



**UniFi** VIDEO<sup>®</sup>

UniFi Video Camera G3 Flex  
Ceiling Mount Accessory  
Model: UVC-G3-F-C

QUICK START GUIDE

## Introduction

Thank you for purchasing the Ubiquiti Networks® UniFi® Video Camera G3 Flex Ceiling Mount Accessory. This Quick Start Guide is designed to guide you through installation and includes warranty terms.

## Package Contents



Ceiling Mount  
Bracket



Ceiling Backing  
Plate



Mounting  
Cover



Security Screw



Screws  
(Qty. 3)



Screw Anchors  
(Qty. 3)

## Installation Requirements

- UniFi Video Camera G3 Flex (sold separately)
- Refer to the [UVC-G3-FLEX Quick Start Guide](#) for camera installation instructions
- Phillips screwdriver
- Drill and bit (6 mm for drywall anchors or 3 mm for screws)
- Category 5 (or higher) cable for indoor installations

TERMS OF USE: All Ethernet cabling runs must use CAT5 (or above). Shielded Ethernet cable and earth grounding must be used for outdoor installations as conditions of product warranty. TOUGHcable™ is designed for outdoor installations. It is the professional installer's responsibility to follow local country regulations.

## Hardware Overview

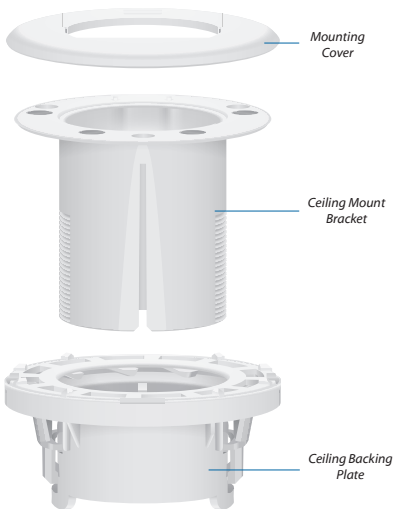

**Note:** Use of the *Ceiling Backing Plate* is optional depending on the installation type.

## Before You Begin

1. Disassemble the separate pieces of the ceiling accessory:
  - a. Push in the two side clips of the *Ceiling Backing Plate* to release the backing plate from the *Ceiling Mount Bracket*.
  - b. Pull the *Mounting Cover* off of the *Ceiling Mount Bracket*.

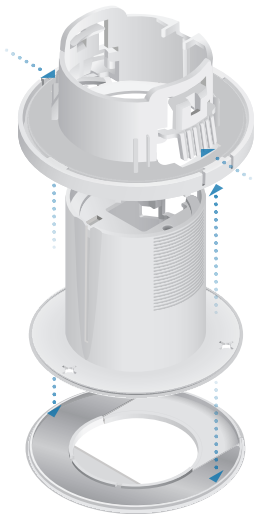



## Hardware Installation

The ceiling accessory can be installed in one of the following ceiling materials:

- **Soft Ceiling** Use for installation on removable ceiling tiles where you have rear access to the *Ceiling Mount Bracket*.
- **Hard Ceiling** Use for installation on hard lid ceilings where there is no rear access to the *Ceiling Mount Bracket*.
- **Drywall** Use for installation on drywall surfaces where *Screw Anchors* are required.

Proceed to the appropriate section for your installation.

 **Note:** We recommend using the *Ceiling Backing Plate* in any installation where you have rear access to the *Ceiling Mount Bracket* once the camera has been installed.

 **Note:** To change the viewing angle of the camera at any time:

- Tilt the lens up or down for vertical adjustment.
- Turn the base left or right for horizontal adjustment.



## Soft Ceiling Installation

1. Remove the ceiling tile.
2. Cut a 2 1/8-inch (53 mm) opening in the ceiling tile.
3. Place the *Ceiling Mount Bracket* through the opening in the ceiling.



**Note:** Ensure that the arrows on the *Ceiling Mount Bracket* point in the direction the camera will face.

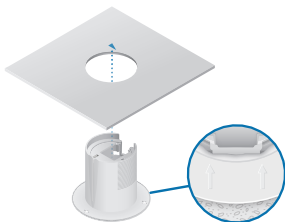

4. Align the notches of the *Ceiling Backing Plate* with the tabs on the *Ceiling Mount Bracket*. Slide the *Ceiling Backing Plate* onto the *Ceiling Mount Bracket*. Then feed an Ethernet cable through the *Ceiling Backing Plate*, *Ceiling Mount Bracket*, and ceiling tile.

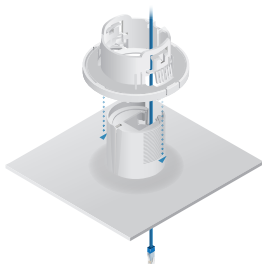

5. Connect one end of the Ethernet cable to the Ethernet port on the camera and the other end to a PoE 802.3af-compliant switch or compatible PoE adapter.

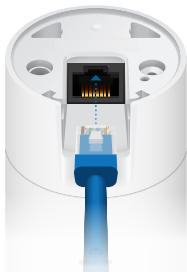

6. Align the notches on the camera with the tabs on the *Ceiling Mount Bracket*. Slide the camera up into the *Ceiling Mount Bracket*, locking into place.

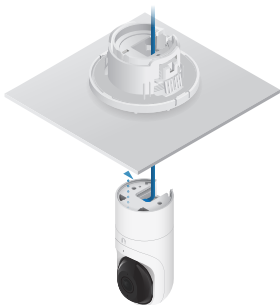

7. Use a Phillips screwdriver to install the included *Security Screw* through the *Ceiling Mount Bracket* and into the base of the camera.

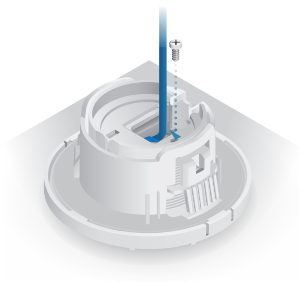

8. Proceed to the *Mounting Cover Installation* section.



## Hard Ceiling Installation

1. Align the notches on the camera with the tabs on the *Ceiling Mount Bracket*. Slide the camera into the *Ceiling Mount Bracket*, locking into place.



2. Use a Phillips screwdriver to install the included *Security Screw* through the *Ceiling Mount Bracket* and into the base of the camera.



3. Cut a 2 1/8-inch (53 mm) opening in the ceiling and pull an Ethernet cable through the opening.

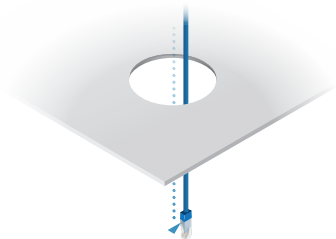

4. Connect one end of the Ethernet cable to the Ethernet port on the camera and the other end to a PoE 802.3af-compliant switch or compatible PoE adapter.

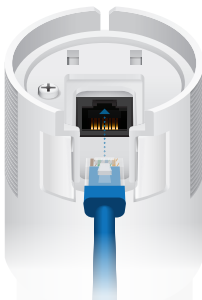

5. Place the *Ceiling Mounting Bracket* through the opening in the ceiling.



**Note:** Ensure that the arrows on the *Ceiling Mount Bracket* point in the direction the camera will face.



6. Use the three *Screws* to secure the *Ceiling Mount Bracket* to the ceiling.



7. Proceed to the *Mounting Cover Installation* section.

## Drywall Ceiling Installation

1. Cut a 2 1/8-inch (53 mm) opening in the ceiling.
2. Place the *Ceiling Mount Bracket* through the opening in the ceiling. Using the *Ceiling Mount Bracket* as a template, mark the three screw holes.

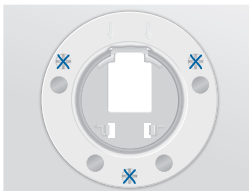

 **Note:** Ensure that the arrows on the *Ceiling Mount Bracket* point in the direction the camera will face.

3. Remove the *Ceiling Mount Bracket* from the ceiling opening and pre-drill the screw holes, using a 6 mm drill bit.
4. Align the notches on the camera with the tabs on the *Ceiling Mount Bracket*. Slide the camera into the *Ceiling Mount Bracket*, locking into place.



5. Use a Phillips screwdriver to install the included *Security Screw* through the *Ceiling Mount Bracket* and into the base of the camera.

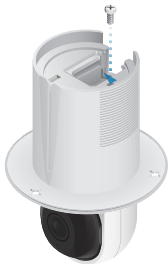

6. Insert the three *Screw Anchors* into the three screw holes and then feed an Ethernet cable through the ceiling.

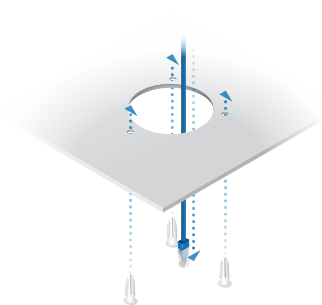

7. Connect one end of the Ethernet cable to the Ethernet port on the camera and the other end to a PoE 802.3af-compliant switch or compatible PoE adapter.

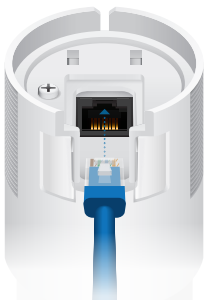

8. Align the *Ceiling Mount Bracket* with the *Screw Anchors*.

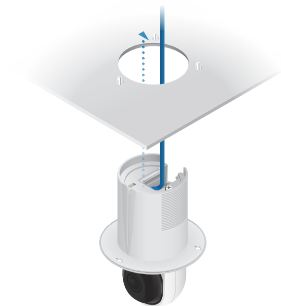

9. To secure the *Ceiling Mount Bracket* to the ceiling, insert the three *Screws* into the three screw holes and *Screw Anchors*.



10. Proceed to the *Mounting Cover Installation* section.

## Mounting Cover Installation

Once the ceiling accessory and camera have been installed in the ceiling, follow the steps below to install the *Mounting Cover*:

1. Unlock the *Mounting Cover* by sliding the tab out.



2. Place the open *Mounting Cover* over the camera and *Ceiling Mount Bracket*.

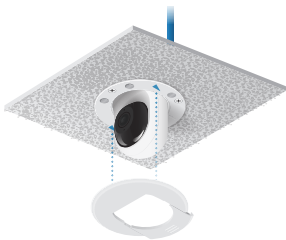

3. Lock the *Mounting Cover* into place by sliding the tab closed.

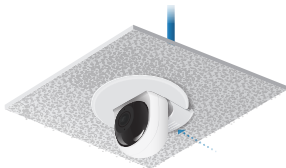



## Limited Warranty

UBIQUITI NETWORKS, Inc (“UBIQUITI NETWORKS”) warrants that the product(s) furnished hereunder (the “Product(s)”) shall be free from defects in material and workmanship for a period of one (1) year from the date of shipment by UBIQUITI NETWORKS under normal use and operation. UBIQUITI NETWORKS’ sole and exclusive obligation and liability under the foregoing warranty shall be for UBIQUITI NETWORKS, at its discretion, to repair or replace any Product that fails to conform to the above warranty during the above warranty period. The expense of removal and reinstallation of any Product is not included in this warranty. The warranty period of any repaired or replaced Product shall not extend beyond its original term.

## Warranty Conditions

The above warranty does not apply if the Product:

- (I) has been modified and/or altered, or an addition made thereto, except by Ubiquiti Networks, or Ubiquiti Networks’ authorized representatives, or as approved by Ubiquiti Networks in writing;
- (II) has been painted, rebranded or physically modified in any way;
- (III) has been damaged due to errors or defects in cabling;
- (IV) has been subjected to misuse, abuse, negligence, abnormal physical, electromagnetic or electrical stress, including lightning strikes, or accident;
- (V) has been damaged or impaired as a result of using third party firmware;
- (VI) has no original Ubiquiti MAC label, or is missing any other original Ubiquiti label(s); or
- (VII) has not been received by Ubiquiti within 30 days of issuance of the RMA.

In addition, the above warranty shall apply only if: the product has been properly installed and used at all times in accordance, and in all material respects, with the applicable Product documentation; all Ethernet cabling runs use CAT5 (or above), and for outdoor installations, shielded Ethernet cabling is used, and for indoor installations, indoor cabling requirements are followed.

## Returns

No Products will be accepted for replacement or repair without obtaining a Return Materials Authorization (RMA) number from UBIQUITI NETWORKS during the warranty period, and the Products being received at UBIQUITI NETWORKS’ facility freight prepaid in accordance with the RMA process of UBIQUITI NETWORKS. Products returned without an RMA number will not be processed and will be returned freight collect or subject to disposal. Information on the RMA process and obtaining an RMA number can be found at: [www.ubnt.com/support/warranty](http://www.ubnt.com/support/warranty)

## Disclaimer

EXCEPT FOR ANY EXPRESS WARRANTIES PROVIDED HEREIN, UBIQUITI NETWORKS, ITS AFFILIATES, AND ITS AND THEIR THIRD PARTY DATA, SERVICE, SOFTWARE AND HARDWARE PROVIDERS HEREBY DISCLAIM AND MAKE NO OTHER REPRESENTATION OR WARRANTY OF ANY KIND, EXPRESS, IMPLIED OR STATUTORY, INCLUDING, BUT NOT LIMITED TO, REPRESENTATIONS, GUARANTEES, OR WARRANTIES OF MERCHANTABILITY, ACCURACY, QUALITY OF SERVICE OR RESULTS, AVAILABILITY, SATISFACTORY QUALITY, LACK OF VIRUSES, QUIET ENJOYMENT, FITNESS FOR A PARTICULAR PURPOSE AND NON-INFRINGEMENT AND ANY WARRANTIES ARISING FROM ANY COURSE OF DEALING, USAGE OR TRADE PRACTICE IN CONNECTION WITH SUCH PRODUCTS AND SERVICES. BUYER ACKNOWLEDGES THAT NEITHER UBIQUITI NETWORKS NOR ITS THIRD PARTY PROVIDERS CONTROL BUYER'S EQUIPMENT OR THE TRANSFER OF DATA OVER COMMUNICATIONS FACILITIES, INCLUDING THE INTERNET, AND THAT THE PRODUCTS AND SERVICES MAY BE SUBJECT TO LIMITATIONS, INTERRUPTIONS, DELAYS, CANCELLATIONS AND OTHER PROBLEMS INHERENT IN THE USE OF COMMUNICATIONS FACILITIES. UBIQUITI NETWORKS, ITS AFFILIATES AND ITS AND THEIR THIRD PARTY PROVIDERS ARE NOT RESPONSIBLE FOR ANY INTERRUPTIONS, DELAYS, CANCELLATIONS, DELIVERY FAILURES, DATA LOSS, CONTENT CORRUPTION, PACKET LOSS, OR OTHER DAMAGE RESULTING FROM ANY OF THE FOREGOING. In addition, UBIQUITI NETWORKS does not warrant that the operation of the Products will be error-free or that operation will be uninterrupted. In no event shall UBIQUITI NETWORKS be responsible for damages or claims of any nature or description relating to system performance, including coverage, buyer's selection of products (including the Products) for buyer's application and/or failure of products (including the Products) to meet government or regulatory requirements.

## Limitation of Liability

EXCEPT TO THE EXTENT PROHIBITED BY LOCAL LAW, IN NO EVENT WILL UBIQUITI OR ITS SUBSIDIARIES, AFFILIATES OR SUPPLIERS BE LIABLE FOR DIRECT, SPECIAL, INCIDENTAL, CONSEQUENTIAL OR OTHER DAMAGES (INCLUDING LOST PROFIT, LOST DATA, OR DOWNTIME COSTS), ARISING OUT OF THE USE, INABILITY TO USE, OR THE RESULTS OF USE OF THE PRODUCT, WHETHER BASED IN WARRANTY, CONTRACT, TORT OR OTHER LEGAL THEORY, AND WHETHER OR NOT ADVISED OF THE POSSIBILITY OF SUCH DAMAGES.

## Note

Some countries, states and provinces do not allow exclusions of implied warranties or conditions, so the above exclusion may not apply to you. You may have other rights that vary from country to country, state to state, or province to province. Some countries, states and provinces do not allow the exclusion or limitation of liability for incidental or consequential

damages, so the above limitation may not apply to you. EXCEPT TO THE EXTENT ALLOWED BY LOCAL LAW, THESE WARRANTY TERMS DO NOT EXCLUDE, RESTRICT OR MODIFY, AND ARE IN ADDITION TO, THE MANDATORY STATUTORY RIGHTS APPLICABLE TO THE LICENSE OF ANY SOFTWARE (EMBEDDED IN THE PRODUCT) TO YOU. The United Nations Convention on Contracts for the International Sale of Goods shall not apply to any transactions regarding the sale of the Products.

## Declaration of Conformity

**български [Bulgarian]** С настоящото UBIQUITI NETWORKS декларира, че този тип радиосъоръжение UVC-G3-F-C е в съответствие с Директива 2014/53/ЕС. Цялостният текст на ЕС декларацията за съответствие може да се намери на следния интернет адрес: [www.ubnt.com/compliance](http://www.ubnt.com/compliance)

**Hrvatski [Croatian]** UBIQUITI NETWORKS ovime izjavljuje da je radijska oprema tipa UVC-G3-F-C u skladu s Direktivom 2014/53/EU. Cjeloviti tekst EU izjave o sukladnosti dostupan je na sljedećoj internetskoj adresi: [www.ubnt.com/compliance](http://www.ubnt.com/compliance)

**Čeština [Czech]** Tímto UBIQUITI NETWORKS prohlašuje, že typ rádiového zařízení UVC-G3-F-C je v souladu se směrnici 2014/53/EU. Úplné znění EU prohlášení o shodě je k dispozici na této internetové adrese: [www.ubnt.com/compliance](http://www.ubnt.com/compliance)

**Dansk [Danish]** Hermed erklærer UBIQUITI NETWORKS, at radioudstyretypen UVC-G3-F-C er i overensstemmelse med direktiv 2014/53/EU. EU-overensstemmelseserklæringens fulde tekst kan findes på følgende internetadresse: [www.ubnt.com/compliance](http://www.ubnt.com/compliance)

**Nederlands [Dutch]** Hierbij verklaar ik, UBIQUITI NETWORKS, dat het type radioapparatuur UVC-G3-F-C conform is met Richtlijn 2014/53/EU. De volledige tekst van de EU-conformiteitsverklaring kan worden geraadpleegd op het volgende internetadres: [www.ubnt.com/compliance](http://www.ubnt.com/compliance)

**English** Hereby, UBIQUITI NETWORKS declares that the radio equipment type UVC-G3-F-C is in compliance with Directive 2014/53/EU. The full text of the EU declaration of conformity is available at the following internet address: [www.ubnt.com/compliance](http://www.ubnt.com/compliance)

**Eesti keel [Estonian]** Käesolevaga deklareerib UBIQUITI NETWORKS, et käesolev raadioseadme tüüp UVC-G3-F-C vastab direktiivi 2014/53/EU nõuetele. ELi vastavusdeklaratsiooni täielik tekst on kättesaadav järgmisel internetiaadressil: [www.ubnt.com/compliance](http://www.ubnt.com/compliance)

**Suomi [Finnish]** UBIQUITI NETWORKS vakuuttaa, että radiolaitetyypin UVC-G3-F-C on direktiivin 2014/53/EU mukainen. EU-vaatimustenmukaisuusvakuutuksen täysimittainen teksti on saatavilla seuraavassa internetosoitteessa: [www.ubnt.com/compliance](http://www.ubnt.com/compliance)

**Français [French]** Le soussigné, UBIQUITI NETWORKS, déclare que l'équipement radioélectrique du type UVC-G3-F-C est conforme à la directive 2014/53/UE. Le texte complet de la déclaration UE de conformité est disponible à l'adresse internet suivante: [www.ubnt.com/compliance](http://www.ubnt.com/compliance)

**Deutsch [German]** Hiermit erklärt UBIQUITI NETWORKS, dass der Funkanlagentyp UVC-G3-F-C der Richtlinie 2014/53/EU entspricht. Der vollständige Text der EU-Konformitätserklärung ist unter der folgenden Internetadresse verfügbar: [www.ubnt.com/compliance](http://www.ubnt.com/compliance)

**Ελληνικά [Greek]** Με την παρούσα ο/η UBIQUITI NETWORKS, δηλώνει ότι ο ραδιοεξοπλισμός UVC-G3-F-C πληροί την οδηγία 2014/53/ΕΕ. Το πλήρες κείμενο της δήλωσης συμμόρφωσης ΕΕ διατίθεται στην ακόλουθη ιστοσελίδα στο διαδίκτυο: [www.ubnt.com/compliance](http://www.ubnt.com/compliance)

**Magyar [Hungarian]** UBIQUITI NETWORKS igazolja, hogy a UVC-G3-F-C típusú rádióberendezés megfelel a 2014/53/EU irányelvnek. Az EU-megfelelőségi nyilatkozat teljes szövege elérhető a következő internetes címen: [www.ubnt.com/compliance](http://www.ubnt.com/compliance)

**Íslenska [Icelandic]** Hér með lýsir UBIQUITI NETWORKS yfir því að UVC-G3-F-C er í samræmi við grunnkröfur og aðrar kröfur, sem gerðar eru í tilskipun 2014/53/EU. Fullur texti ESB samræmisýfirlýsing er að finna á eftirfarandi netfangi: [www.ubnt.com/compliance](http://www.ubnt.com/compliance)

**Italiano [Italian]** Il fabbricante, UBIQUITI NETWORKS, dichiara che il tipo di apparecchiatura radio UVC-G3-F-C è conforme alla direttiva 2014/53/UE. Il testo completo della dichiarazione di conformità UE è disponibile al seguente indirizzo Internet: [www.ubnt.com/compliance](http://www.ubnt.com/compliance)

**Latviešu valoda [Latvian]** Ar šo UBIQUITI NETWORKS deklarē, ka radioiekārta UVC-G3-F-C atbilst Direktīvai 2014/53/ES. Pilns ES atbilstības deklarācijas teksts ir pieejams šādā interneta vietnē:

**[www.ubnt.com/compliance](http://www.ubnt.com/compliance)**

**Lietuvių kalba [Lithuanian]** Aš, UBIQUITI NETWORKS, patvirtinu, kad radijo įrenginių tipas UVC-G3-F-C atitinka Direktyvą 2014/53/ES. Visas ES atitikties deklaracijos tekstas prieinamas šiuo interneto adresu:

**[www.ubnt.com/compliance](http://www.ubnt.com/compliance)**

**Malti [Maltese]** B'dan, UBIQUITI NETWORKS, niddikjara li dan it-tip ta' taghmir tar-radju UVC-G3-F-C huwa konformi mad-Direttiva 2014/53/UE. Id-dikjarazzjoni tal-konformità tista' tiġi kkonsultata minn

**[www.ubnt.com/compliance](http://www.ubnt.com/compliance)**

**Norsk [Norwegian]** UBIQUITI NETWORKS erklærer herved at utstyret UVC-G3-F-C er i samsvar med de grunnleggende krav og øvrige relevante krav i direktiv 2014/53/EU. Den fulle teksten til EU-samsvarserklæringen er tilgjengelig på følgende nettadresse: **[www.ubnt.com/compliance](http://www.ubnt.com/compliance)**

**Polski [Polish]** UBIQUITI NETWORKS niniejszym oświadczam, że typ urządzenia radiowego UVC-G3-F-C jest zgodny z dyrektywą 2014/53/UE. Pełny tekst deklaracji zgodności UE jest dostępny pod następującym adresem internetowym: **[www.ubnt.com/compliance](http://www.ubnt.com/compliance)**

**Português [Portuguese]** O(a) abaixo assinado(a) UBIQUITI NETWORKS declara que o presente tipo de equipamento de rádio UVC-G3-F-C está em conformidade com a Diretiva 2014/53/UE. O texto integral da declaração de conformidade está disponível no seguinte endereço de Internet:

**[www.ubnt.com/compliance](http://www.ubnt.com/compliance)**

**Română [Romanian]** Prin prezenta, UBIQUITI NETWORKS declară că tipul de echipamente radio UVC-G3-F-C este în conformitate cu Directiva 2014/53/UE. Textul integral al declarației UE de conformitate este disponibil la următoarea adresă internet: **[www.ubnt.com/compliance](http://www.ubnt.com/compliance)**

**Slovenčina [Slovak]** UBIQUITI NETWORKS týmto vyhlasuje, že rádiové zariadenie typu UVC-G3-F-C je v súlade so smernicou 2014/53/EÚ. Úplné EÚ vyhlásenie o zhode je k dispozícii na tejto internetovej adrese: **[www.ubnt.com/compliance](http://www.ubnt.com/compliance)**

**Slovenščina [Slovenian]** UBIQUITI NETWORKS potrjuje, da je tip radijske opreme UVC-G3-F-C skladen z Direktivo 2014/53/EU. Celotno besedilo izjave EU o skladnosti je na voljo na naslednjem spletnem naslovu: **[www.ubnt.com/compliance](http://www.ubnt.com/compliance)**

**Español [Spanish]** Por la presente, UBIQUITI NETWORKS declara que el tipo de equipo radioeléctrico UVC-G3-F-C es conforme con la Directiva 2014/53/UE. El texto completo de la declaración UE de conformidad está disponible en la dirección Internet siguiente: **[www.ubnt.com/compliance](http://www.ubnt.com/compliance)**

**Svenska [Swedish]** Härmed försäkrar UBIQUITI NETWORKS att denna typ av radioutrustning UVC-G3-F-C överensstämmer med direktiv 2014/53/EU. Den fullständiga texten till EU-försäkran om överensstämmelse finns på följande webbadress: **[www.ubnt.com/compliance](http://www.ubnt.com/compliance)**

## Online Resources

Website [www.ubnt.com](http://www.ubnt.com)

Support [help.ubnt.com](http://help.ubnt.com)

Community [community.ubnt.com](http://community.ubnt.com)

Downloads [downloads.ubnt.com](http://downloads.ubnt.com)



Ubiquiti Networks, Inc.  
685 Third Avenue, 27th Floor  
New York, NY 10017  
USA

©2018 Ubiquiti Networks, Inc. All rights reserved. Ubiquiti, Ubiquiti Networks, the Ubiquiti U logo, the Ubiquiti beam logo, TOUGH Cable, UniFi, and UniFi Video are trademarks or registered trademarks of Ubiquiti Networks, Inc. in the United States and in other countries. All other trademarks are the property of their respective owners.

NB043018